



**RECESSED SPOTLIGHT
4.0071**

EXTERIOR

IP67



- › Compact spotlight for variable use
- › Up to 495 lumen light intensity
- › LED unit can be rotated and swivelled





4.0071 | RECESSED SPOTLIGHT

FOR LIGHTING AND ACCENTUATING EXTERIOR, FAÇADES, BUILDINGS, TREES AND PUBLIC SPACES.



- Protection class IP67
- Entirely made of stainless steel 316Ti
- Round or square attachment cover, height 3mm
- ...
- POW-LED cold white, warm white, neutral white
- POW-LED blue
- POW-LED RGB
- operating mode: constant current
- low voltage halogen QR-CB51 ES 12 V-AC
- 360° pivotable and +/-15° adjustable
- Rotationally symmetric light distribution
- ...
- Cable screw fixture M16
- including installation housing made of POM plastic for wall and floor installation
- Supplied with lamp and 3m of underwater cable
- Constant-current power source/RGB controller/external transformer

+ ADDITIONAL PARTS

 glass disc, frosted
for softer light distribution (light loss approx. -15%)
4.0071.00.20

 anti-glare louver
black, for 3 POW-LED and halogene
4.0071.00.50

★ PRODUCT LINE

 **4.0171**
Recessed spotlights
(underwater)
> Page 96

 **4.0072**
Surface spotlights
> Page 122



RECESSED SPOTLIGHT 4.0071

EXTERIOR

IP67



Installation sleeve

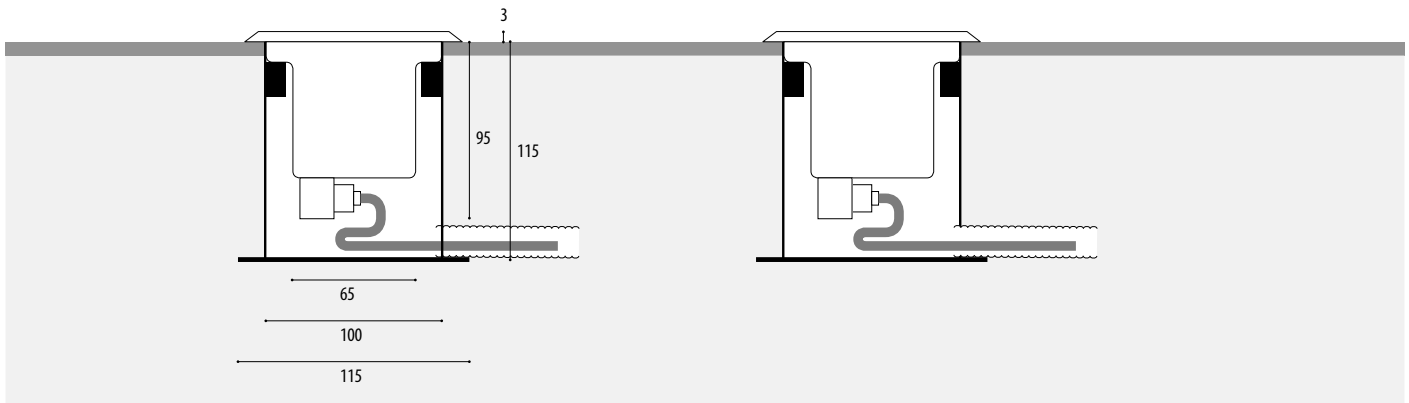
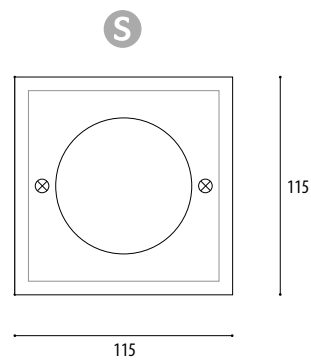
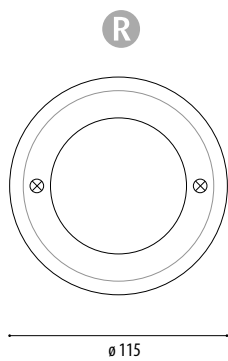

R	S	Article number	Article number	Lamps	Lumen	Light colour	Wattage	Current	Temperature	Radation angle	Cable, installs	[V]
POW-LED, RADATION ANGLE SPOT												
		4.0071.20.01	4.0071.40.01	3 POW-LED	495 lm	6000K cold white	total 5 W	CC 350 mA	<40°C	10° spot	UW, 2x1,5 qmm	V32
		4.0071.20.02	4.0071.40.02	3 POW-LED	405 lm	3000K warm white	total 5 W	CC 350 mA	<40°C	10° spot	UW, 2x1,5 qmm	
		4.0071.20.03	4.0071.40.03	3 POW-LED	465 lm	4500K neutral white	total 5 W	CC 350 mA	<40°C	10° spot	UW, 2x1,5 qmm	
		4.0071.20.06	4.0071.40.06	3 POW-LED	400 mW/LED	blue	total 5 W	CC 350 mA	<40°C	10° spot	UW, 2x1,5 qmm	
		4.0071.20.09	4.0071.40.09	3 POW-LED		RGB	all on 5 W	CC 350 mA	<40°C	10° spot	UW, 6x0,5 qmm	
POW-LED, RADATION ANGLE 30° (MEDIUM)												
		4.0071.20.11	4.0071.40.11	3 POW-LED	495 lm	6000K cold white	total 5 W	CC 350 mA	<40°C	30° medium	UW, 2x1,5 qmm	V33
		4.0071.20.12	4.0071.40.12	3 POW-LED	405 lm	3000K warm white	total 5 W	CC 350 mA	<40°C	30° medium	UW, 2x1,5 qmm	
		4.0071.20.13	4.0071.40.13	3 POW-LED	465 lm	4500K neutral white	total 5 W	CC 350 mA	<40°C	30° medium	UW, 2x1,5 qmm	
		4.0071.20.16	4.0071.40.16	3 POW-LED	400 mW/LED	blue	total 5 W	CC 350 mA	<40°C	30° medium	UW, 2x1,5 qmm	
		4.0071.20.19	4.0071.40.19	3 POW-LED		RGB	all on 5 W	CC 350 mA	<40°C	30° medium	UW, 6x0,5 qmm	
HALOGEN												
		4.0071.20.20	4.0071.40.20	QR-CBC51 (IRC)	300	3000K	20W	12V-AC	80°	36°	UW, 2x1,5 qmm	C63
		4.0071.20.35	4.0071.40.35	QR-CBC51 (IRC)	620	3000K	35W	12V-AC	90°C	36°	UW, 2x1,5 qmm	C73



IP67

EXTERIOR



< Project
Roundabout, Leingarten, Germany

NOTE



rotatable and +/-15° adjustable



Plastic installation housing included, V4A stainless steel installation housing on request

OPTIONS

Possible beam angle POW-LED

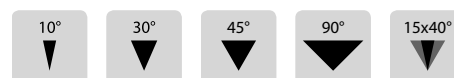

Possible beam angle HALOGENE



POW-LED monochrome, single colour in green, red, amber, turquoise



230 V version

230 V

Power supplies Technical details see from page 234.

5.0635.65.03		5.0635.65.10		5.0635.65.20	
5.0635.65.03	Constant Current power supply, max 1 spotlights	5.0635.65.10	Constant Current power supply, max 2 spotlights	5.0635.65.20	Constant Current power supply, max 2-4 spotlights
5.0635.65.03		5.0635.65.10		5.0635.65.20	
5.0635.65.03		5.0635.65.10		5.0635.65.20	
5.0635.09.16	RGB-Controller, max 4	5.0635.09.50	RGB-Controller, max 12 spotlights		

5.0635.65.03		5.0635.65.10		5.0635.65.20	
5.0635.65.03	Constant Current power supply, max 1 spotlights	5.0635.65.10	Constant Current power supply, max 2 spotlights	5.0635.65.20	Constant Current power supply, max 2-4 spotlights
5.0635.65.03		5.0635.65.10		5.0635.65.20	
5.0635.65.03		5.0635.65.10		5.0635.65.20	
5.0635.09.16	RGB-Controller, max 4	5.0635.09.50	RGB-Controller, max 12 spotlights		

HALOGEN

5.0098.00.00	Transformer, max 2 spotlights
5.0098.00.00	Transformer, max 1 spotlights